

## 1. Summary

Philips Model 1173 Intercom. Serial No. 1064. eBay April 2009

Microphone step-up transformer to volume pot and then 6N8 pentode and then 12AU7 cathode biased triode and then 12AU7 split-load PI then 6M5 pentode push-pull with common cathode bias. Output transformer secondary feedback to 12AU7 triode cathode, and to 6N8 grid. 6N8 screen un-bypassed. 6N8 dual diodes fed back to grid leak bias.

Appears unused. No power cable. All components pristine.

### Components

Output Transformer 'TYPE 2517' and '2799', and marked with 62 and 62 on secondaries.

Power Transformer '344.086', '13x9'. 250-CT-250, 6V3 ~3A, 6V3 ~0.5A

Microphone Tx Brown metal encased.

CAPs Ducon 24uF 300V and 8uF 300V

Tubes (all Miniwatt) 6V4

6M5 M+2 C6G (M+=EL80=6M5; C6G=Hendon Works; 6=1956)

6M5 M+ 9E (M+=EL80=6M5; 9E=1959 ??)

12AU7 ▲8C (Philips, 1958, March) 8G (CV4034 – long life version of 12AU7)

6N8 4R 8J (4R=EBF80=6N8; 8J=1958 ??)

Rola C 3" speaker with 600/3.5Ω step-down transformer (dated 18 Mar 1960).

## INTER-COMMUNICATION EQUIPMENT



The Master Control Inter-communication System is designed to give efficient communication between a Master Control unit and an unlimited number of Remote Stations, at an extremely low cost of installation, yet with this outstanding advantage — the person called on the Remote Station DOES NOT HAVE TO INTERRUPT HIS WORK to answer the call! No 'phones to pick up — no buttons to press! HE MERELY REPLIES IN THE DIRECTION OF THE REMOTE STATION.

These units receive and transmit speech from a person up to 60ft. away in quiet locations, and up to 30ft. where a noisy background prevails. The Master Station selects and speaks to any single Remote Station. A great many variations can be made to the Standard System, such as Secret Remote Stations, inclusion of ordinary loudspeakers, etc. Write for a free brochure for further particulars. **Master Control Units are available in 6 or 12 Station units.**

### SPECIAL TWO-STATION UNIT

This simple low-cost two-way unit is indispensable in — dining-room to kitchen (hotels and cafes) — surgery to receptionist — permanent invalid to nurse, etc. As can be imagined, this system has unlimited possibilities. No more time wasted in walking back and forth — just flick a key and speak! Let us demonstrate how this remarkable little inter-com works.



### Issues:

No power switch. Wax capacitors leaky. 6V4 shorting. A few poor joints. Output transformer secondary impedance.



### 1.1 Modifications for Guitar Amplifier

The 6N8 and 6M5 valves are rarely seen in a guitar amplifier, but were typical of Australian 1950-60's domestic radio/audio equipment.

- On/off switch added to rear panel.
- Fuse added to PT secondary CT (125mA T 5x20).
- 1N4007 added in series with each rectifier plate for 6V4.
- Electrolytics and wax coupling caps replaced. 2x 15uF for VS1.
- 6N8 grid-biased pentode input stage changed to cathode-biased triode with 15k input stopper.
- A standard Fender tonestack added, with 250K, 10K, 250K pots.
- Volume pot (1M $\Omega$ ) at end of Tone stack, and input to first section of 12A7.
- Send/return 6.5mm socket inserted with tip=return, and ring=send.
- 15k grid stopper added to tone-recovery gain stage, and feedback to cathode removed.
- 12AU7 swapped to 12AT7.
- 470k grid stopper added to PI stage.
- 6M5 cathode 10 $\Omega$  sense resistors added.
- 6M5 screen stoppers added, and common dropper resistor-capacitor from VS1.
- RC network across PP removed. 330VDC 90pF MOVs added across each OT half-winding.
- Microphone transformer and relay removed.
- Heater winding humdinger pot added and elevated wiper to abt. +30Vdc. 27k in series with 150k bleed, and bypassed.
- Fitted 5-pin McMurdo socket for monitoring, and added 180k+1k8+68 divider for VS1.
- OT removed and TU-208 12000 fitted for 12k $\Omega$ :8 $\Omega$  ~10W.
- ¼" jack added for external speaker only, with default connection for internal speaker through 120 $\Omega$  2W to limit max power to 0.5Wrms at 8W nominal.

### 1.2 To do:

- Photo of top chassis
- Suppress 100Hz supply level – check if from PI or output stage.
- Measure peak turn-on VS1.
- Measure heater elevation V.

## 2. Measurements

Voltage rail regulation.

Rail VDC, VACrms	240VAC mains 0.25A
VS1 (screen)	284, 3.35 (320V turn-on pk)
VS2	261
VS3	271
VS4	262
Cathode	8.5 (25+23mA) 7W
Heater 1	
Heater 2	
Sec HT	
V1	62, 2.0
V2a	156, 2.5
V2b	78.4, 81.5, 185

Power transformer primary DC resistance: 30Ω (BLU-BLK); 26Ω (RD-BLK).

Power transformer secondary DC resistance: 185+185Ω.

With open-circuit secondaries the outputs are 7.1V, 7.1V and 284V. 6M5 requires 2x 0.71A. 6N8 and 12AU7 requires 0.3A each. Heater current requirement is: 2x 0.71 + 2x 0.3 + 0.6 (6V4) = 2.6A indicates a 250-CT-250, 6V3 3A, 6V3 ~0.5A.

12VAC 50Hz nominal applied to 2517 output transformer (note that this OT was replaced):

Winding	Voltage rms	Turns ratio; Pri Impedance; Spec level; Notes
Pri P-P: BLU to GRN	134.4	1 ; 7500Ω; Appears to be 7K5
Sec: Top 62	12.25	10.97; 7,461 Ω; 62Ω;
Sec: Bottom 62	12.07	11.1; 7,640Ω; 62Ω;

Output transformer primary DC resistance: 190Ω plate-to-plate.

Output transformer secondary DC resistance: 3 Ω, 4Ω.

Secondaries in series need 250Ω, if using a speaker matching transformer.

OT swapped measurements with 16.5Ω resistive load:

500Hz 160mVrms input for 6W (10Vrms in to 16.5Ω resistive load) with vol at max and bass at min, mid at mid, treble at mid. VS1 sagged to 286V at 6W output, and 280V cranked. VS2 sagged to 240V at 6W output, and 220V cranked. Humdinger variation caused no change in noise floor. 6N8 input stage starts soft clipping its output on one side at about 1.3Vrms input level.

Bass pot has nearly all action near full CW – and is reverse control (full CW is min bass boost).

Noticeable sine top distortion at 7Vrms to 8R (6W), with VS1 sag from 279V to 273V but common cathode voltage increase from 8.1V to 9.1V. Signal increase then caused scalloping of one side but not much output signal increase.

9.5mVrms for 5.6V 8R 4W output.

No input signal gives 69mVrms to 8R (input plug in or out) with max gain, reducing to 48mV for min gain. Output stage with 25.4+23.1mA balance.

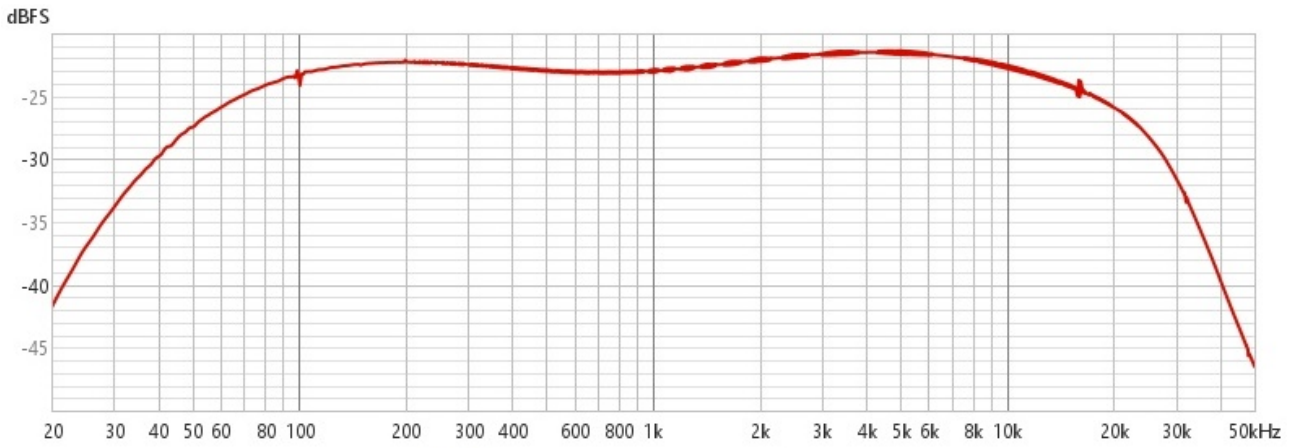

1W 8R bass flat mid min treb mid

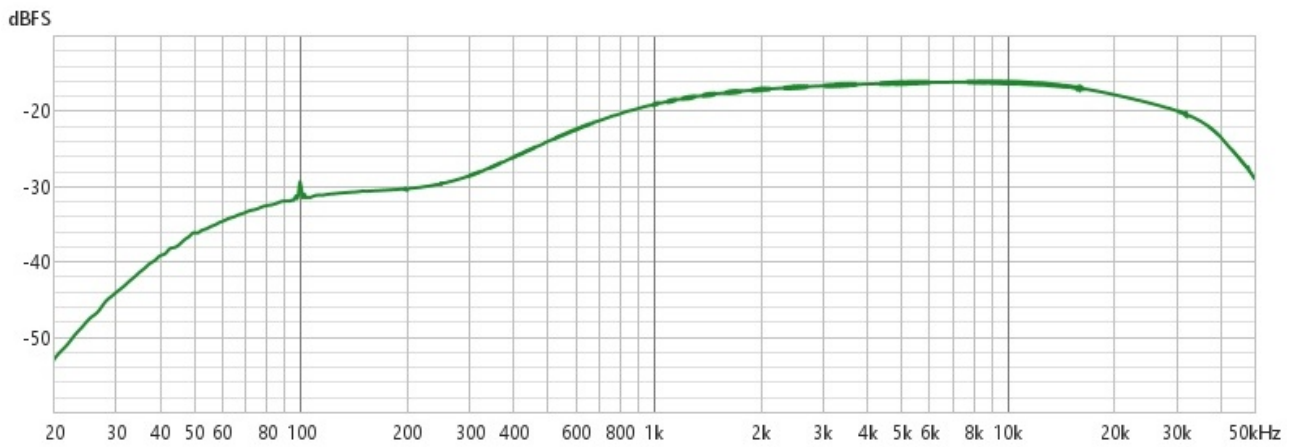

1W 8R bass flat mid mid treb max

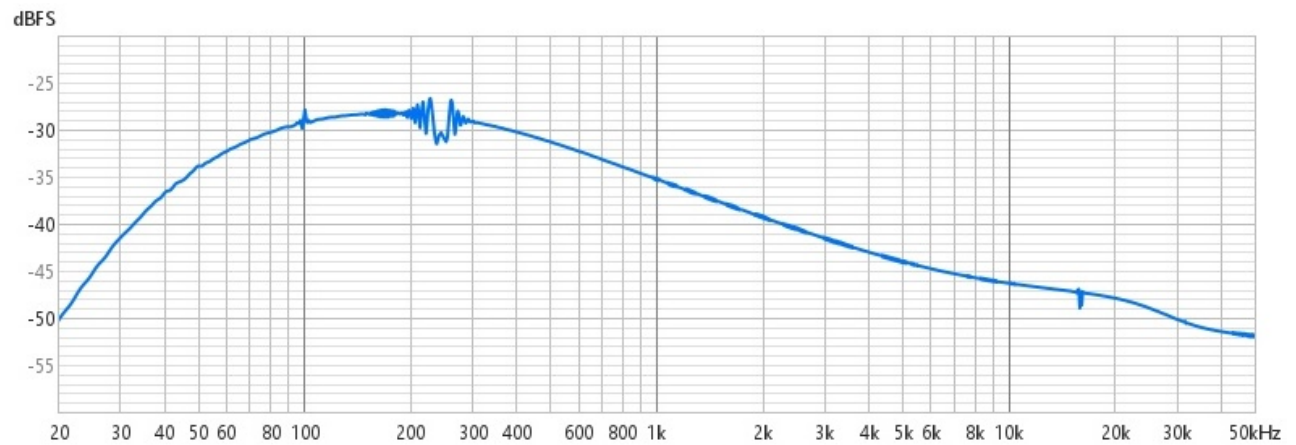

1W 8R bass flat mid max treb min



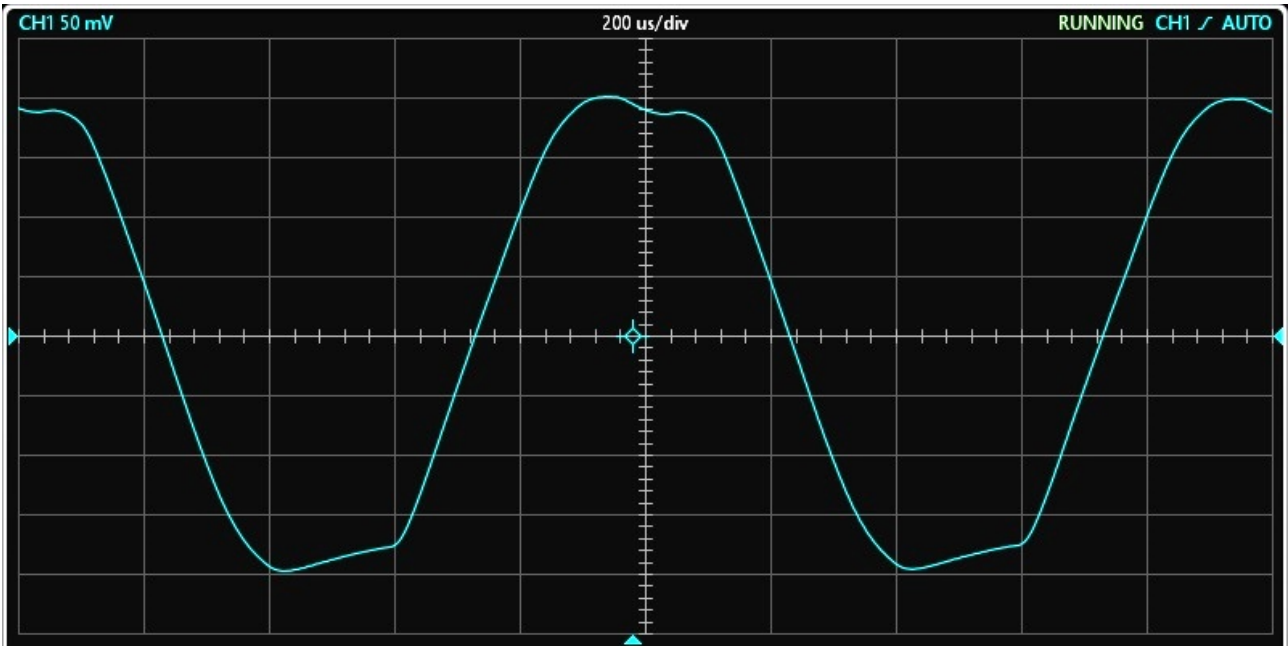

7Vrms 8Ω load (6.1W) 1kHz sinewave.

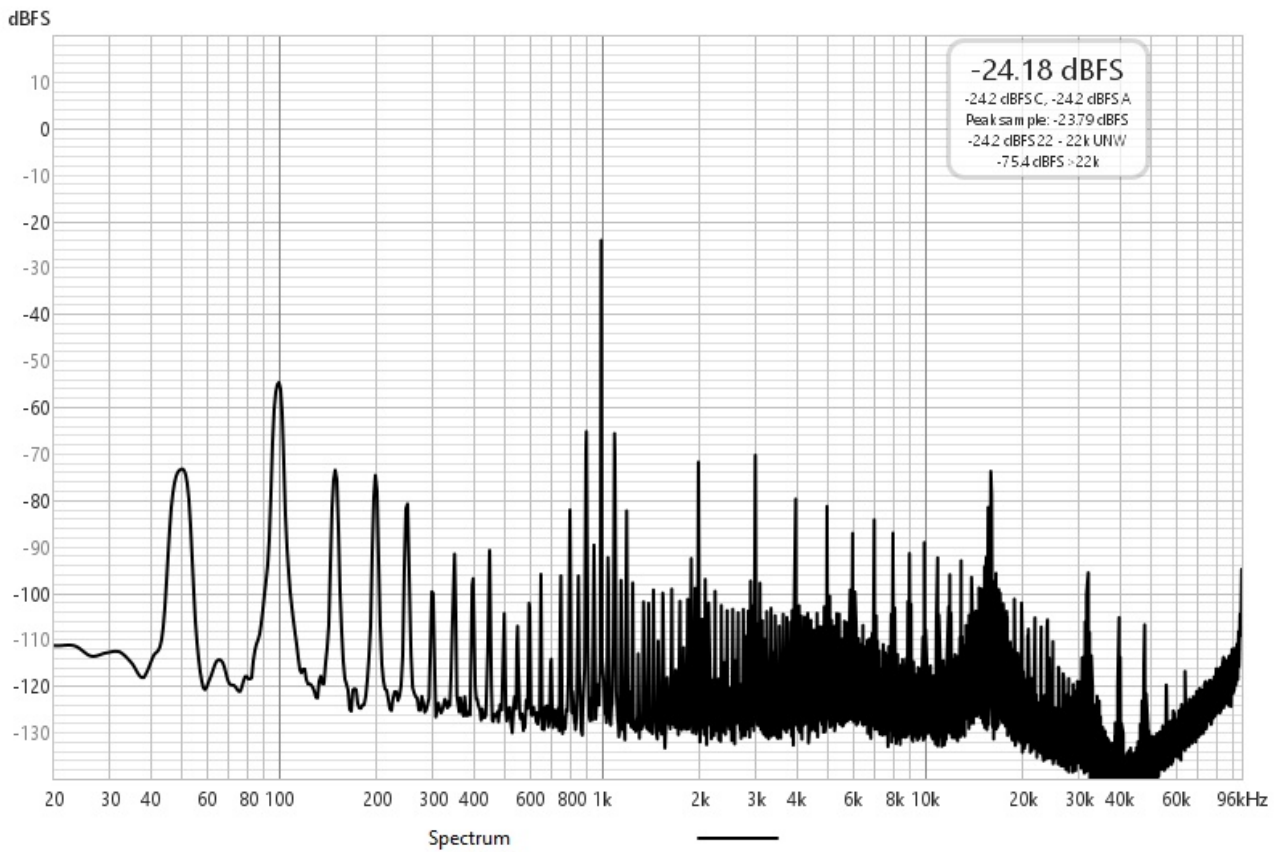

1W 8Ω load 1kHz spectrum

### 3. Design Info

#### 3.1 Input stage 6N8 (EBF80)

Modified from grid-biased pentode, to cathode biased triode. Supply voltage is 262V; load resistance is 100k; cathode resistor is 1k bypassed.  $V_k=2.0V$ ,  $V_a=62V$ . Cathode current =  $2.0/1k = 2.0mA$ . Drop across plate load 200V. The measured bias settings are significantly different from published levels for 1k of 80V – need to try another 6N8 to check.

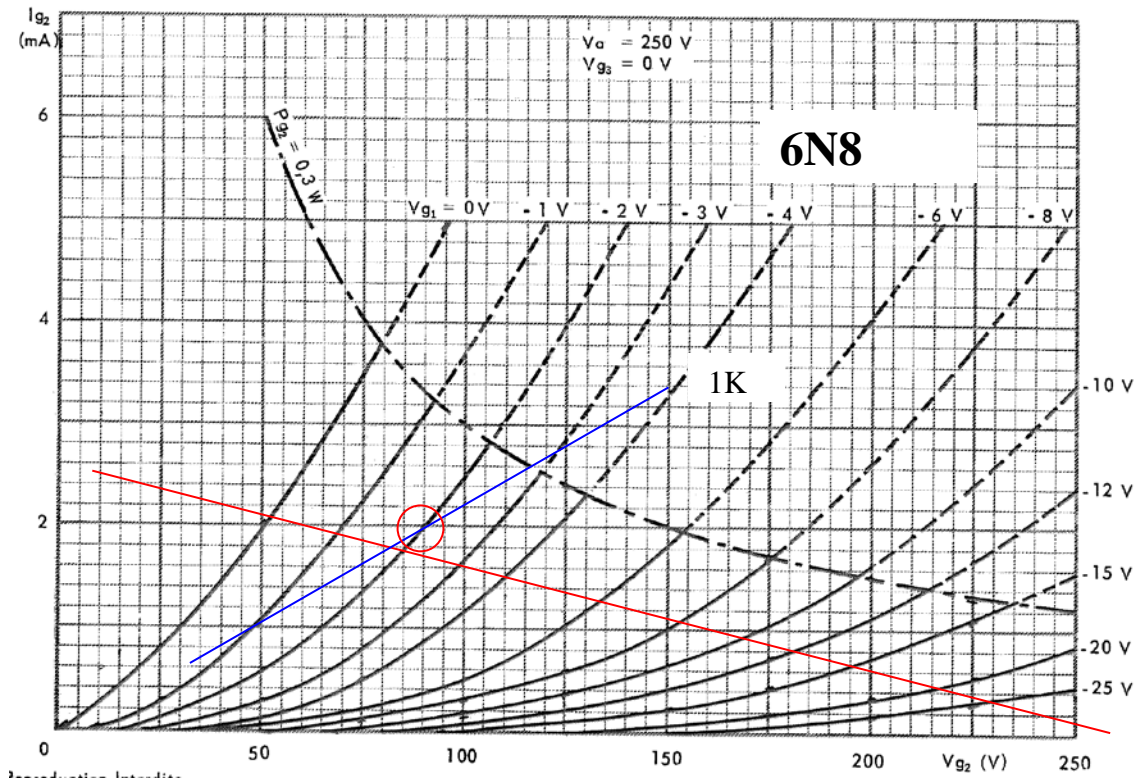

#### 3.2 Mid stage 12AU7

Supply voltage is 252V; load resistance is 100k; and cathode resistor is 2K2 bypassed.  $V_a=84V$ ,  $V_k=3.7V$ , giving cathode current = 1.6mA. The plate voltage  $V_p$  axis intercept is 250V for no plate current, and the plate current  $I_p$  axis intercept is  $250V / 102K\Omega = 2.5mA$ . The gate-cathode voltage ( $E_c$  on the graph) operating point is at  $V_{gc}=2.3K \times 1.6mA = 3.7V$ .

The input voltage swing limit is from the bias point at  $V_{gk}=-3.7V$  to  $V_{gk}=0V$ , which is about 7.4Vpp or 2.6Vrms. Referring to the loadline, the plate voltage would swing about 100V, from about 25V to 125V, with a mid point of 80V [ $125-80=45V$ ;  $80-25=55V$ ] which is fairly symmetric. This gives a nominal gain of  $100/7.4 = 14$ , which is similar to datasheet level.

The gain required for guitar needs at least a 12AT7, and is swapped with no need to change bias or load.  $V_{S3}=271V$ ;  $V_a=156V$ ,  $V_k=2.5V$ .  $I_k=2.5/2.2=1.14mA$ .

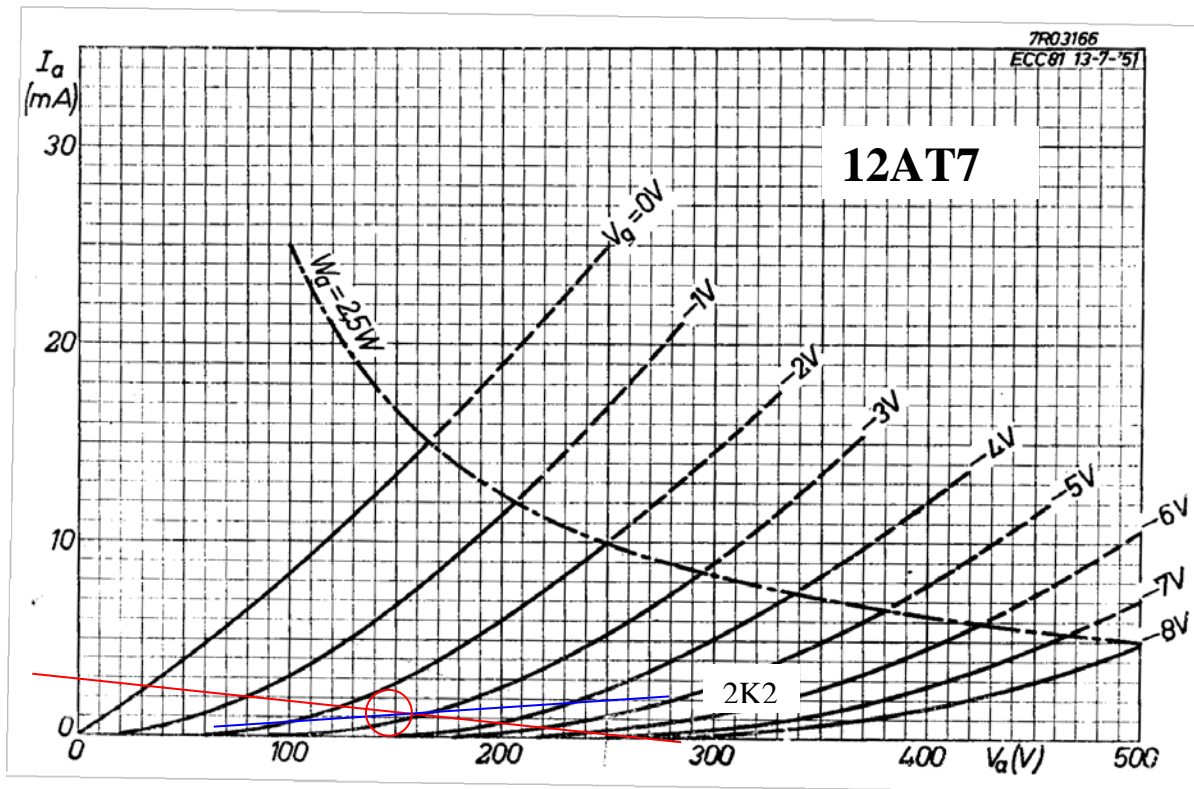
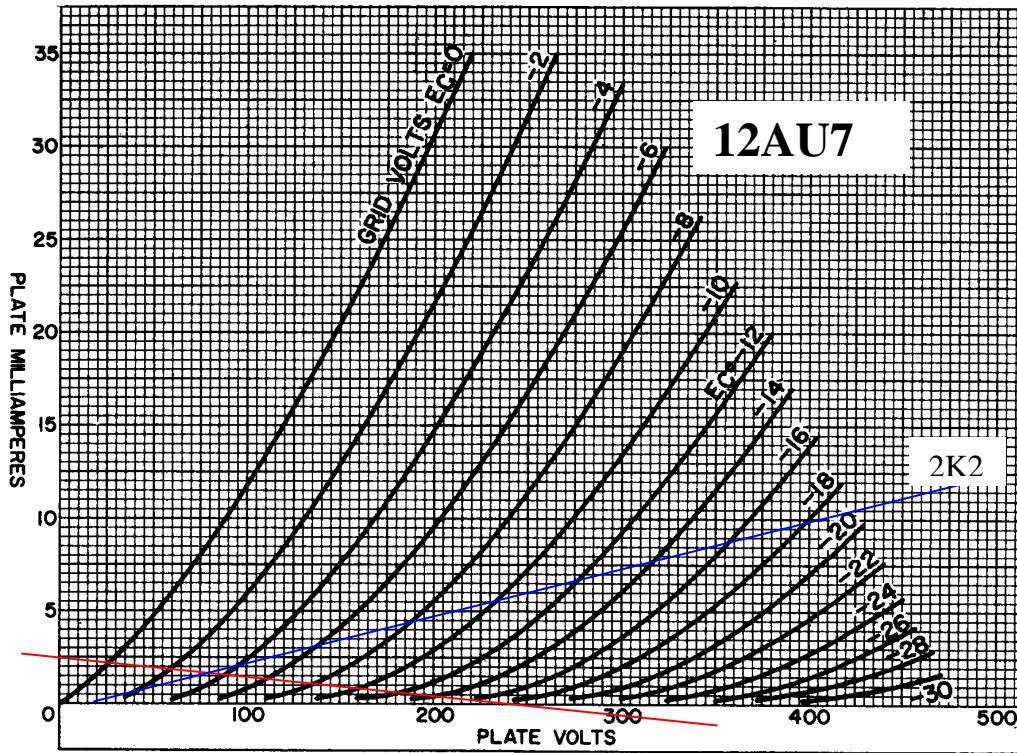

**3.3 Phase Inverter stage – 12AU7 in split-load (cathodyne) config**

$V_{S2} = 237V$ .  $R_k$   $V_{gk} = 69.8 - 63.6V = 6.2V$ .  $V_k = 70.3V$ .  $V_a = 169V$ .  $V_{ak} = 99V$ . Anode current =  $(237 - 169) / 100k = 0.68mA$ .

$V_{ak}$  was modified to 25% of  $V_{S2}$  using 10k, it was at 50V with 2K2. The plate voltage axis intercept is 237V for no plate current, and the plate current  $I_p$  axis intercept is  $237V / 210k\Omega =$

1.0mA. The gate-cathode voltage ( $E_c$  on the graph) operating point at  $V_{gk} = -6.2V$  varies with plate current through the  $10k\Omega$  gate-cathode resistance with the characteristic shown on the graph as a line passing through  $I_p = 0.5mA$  for  $V_{gk} = -5V$ , and through  $I_p = 2mA$  for  $V_{gk} = -20V$ . The intersection of the two lines is the nominal biased operating point. The lack of definition in the 12AU7 curves makes design a little difficult.

To move  $V_{ak}$  to  $\sim 120V$  requires plate current to reduce from 1.2mA down to 0.62V.  $2k2$  was raised to  $6V/0.6mA = 10k$ .

The input voltage swing limit is from the bias point at  $V_{gk} = -6.2V$  to  $V_{gk} = 0V$ , which is about 12.4Vpp or 4.3Vrms. Referring to the loadline, the plate-cathode voltage would swing about 185V, from about 15V to 200V, with a mid point of 100V [ $200 - 100 = 100V$ ;  $100 - 15 = 85V$ ] which is fairly symmetric. The gain of the stage is unity.

Change to 12AT7 has  $V_{S3} = 271V$ ;  $V_a = 185V$ ,  $V_k = 81.5V$ .  $V_{low} = 78.4V$ .  $I_k = 86/100k = 0.86mA$  or 0.78mA.  $V_{ak} = 183V$ . So about mid-biased.

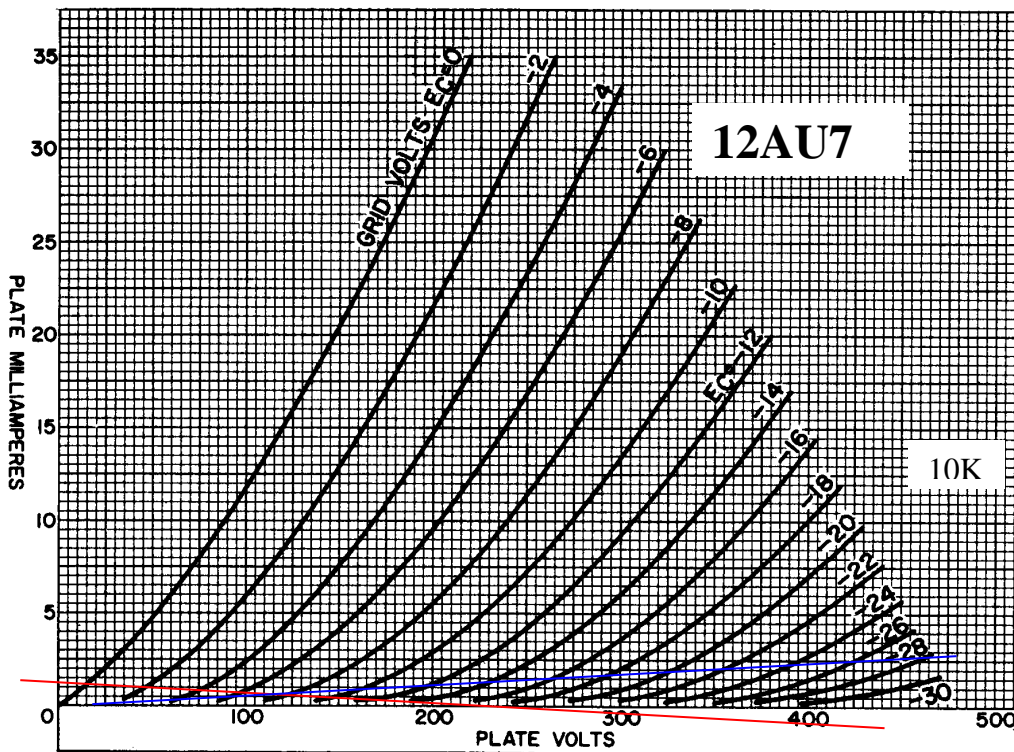



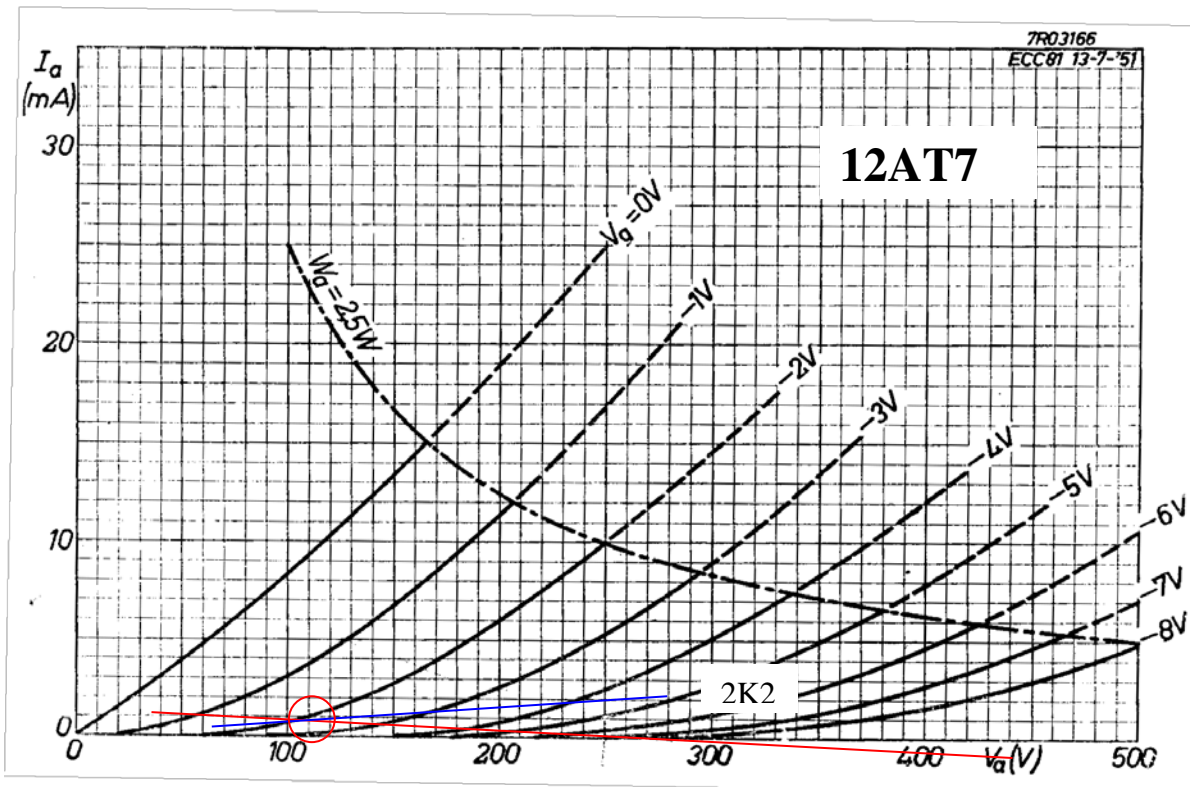

### 3.4 Output Stage

Class AB push-pull output stage, common cathode bias. The 7K5Ω impedance plate-to-plate OPT presents signal currents into each tube with a 3K8Ω impedance with both tubes conducting, to 1K9Ω load impedance at higher levels. No pentode characteristic curves are available for 6M5, and similar EL41 curves are shown. Nominal 9.4W output into 7k PP.

As the output loading increases, the supply voltage VS1 to the output valve plates sags from about 267-8=259V towards 220V. Plate DC voltage will be lower than VS1 by an amount up to ~25V; ie. OPT half resistance of about 85Ω with a peak current of up to about 0.1A, and cathode bias drop of 17V. Screen voltage will vary from about 244-11=233V towards 200V under steady-state heavy load.

The maximum output valve bias current allowed is dependant on the maximum recommended plate dissipation – assume 70% of 9W = 6W:  $I_{bias(max)} = P_d / V_b = 6W / 260V = 23mA$ , based on 6M5 datasheet recommendation of 30mA. The gate bias voltage required for this current is significantly influenced by the screen voltage. Bias voltage at 23mA/tube is  $175 \times 0.046 = 8V$ .

For a peak plate current of 100mA, then the nominal output power of the amplifier would be:  $(I_{pk})^2 \times R_{pp} / 8 = 0.1 \times 0.1 \times 7k5 / 8 = 9.4W$  (which is the datasheet value). For this maximum signal condition, the rms OPT current draw is likely about 64mA (64% of peak), and the average VS1 power consumed is about  $260V \times 0.064A_{rms} = 17W$ , and the OPT loss is about  $(0.064)^2 \times 190\Omega = 0.8W$ , so the tube plates dissipate  $17 - 9.4W - 0.8W = 7W$ , or just under 3.5W each, which is well below max design level.

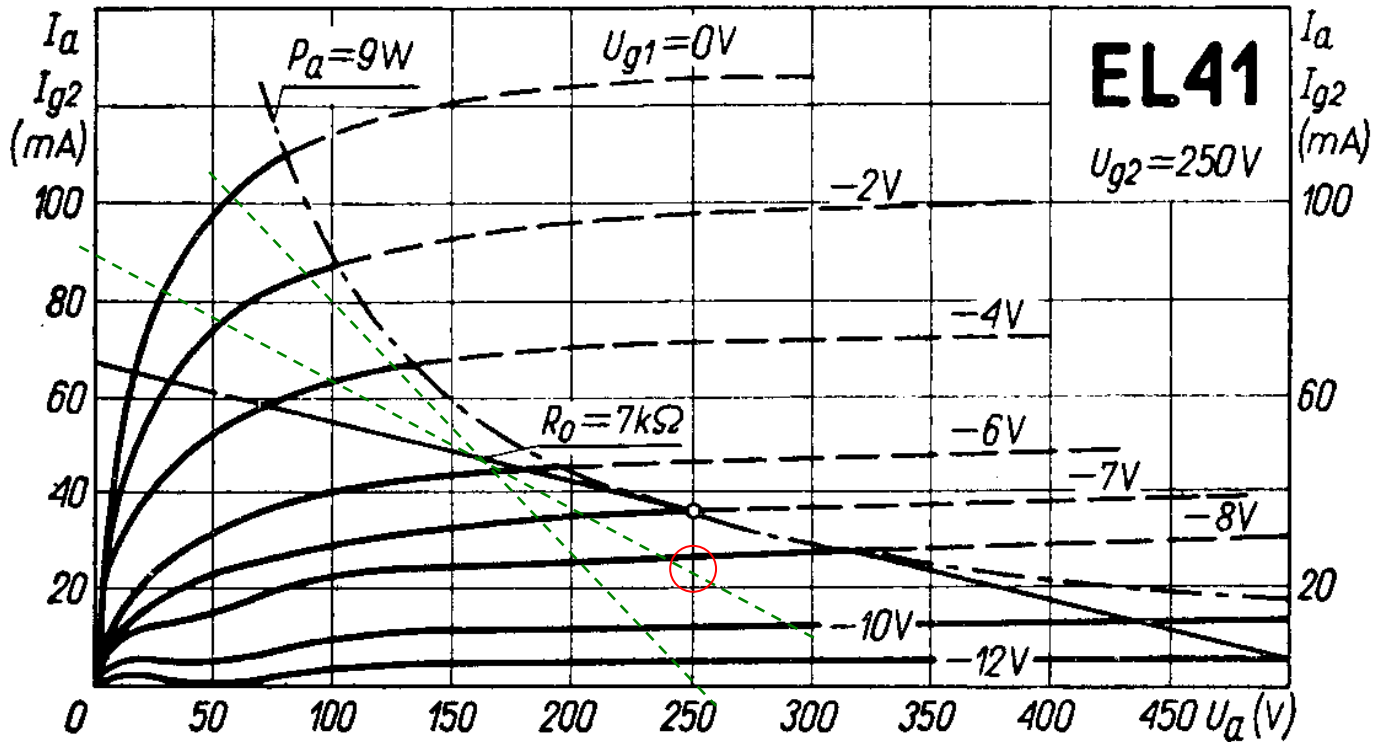

**3.4.1 Modified OT**

Class AB push-pull output stage, common cathode bias. The 12KΩ impedance plate-to-plate OPT presents signal currents into each tube with a 6KΩ impedance with both tubes conducting, to 3KΩ load impedance at higher levels. No pentode characteristic curves are available for 6M5, and similar EL41 curves are shown. 9+1.4W rated dissipation.

Likely ROLA OPT, but not an exact match – closest is CAL61 (12kPP 10Wpk isocore), but 8R secondary and not exact dimensions, and label is TU208 12000, with 200+230 DCR.

Idle Vak is about 283V - 9V - 200x0.025 = 270V. For 25mA cathode current, this is 6.8W or 75% of anode diss rating. The gate bias voltage required for this current is significantly influenced by the screen voltage. Bias voltage at 25mA/tube is 175Ωx0.05A=8.7V.

As the output loading increases, the supply voltage VS1 to the output valve plates sags from about 283V towards 260V. Plate DC voltage will be lower than VS1 by an amount up to ~18+9 =27V; ie. OPT half resistance of about 200Ω with a peak current of up to about 0.09A, and cathode bias drop of 9V. Screen voltage will vary from about 260-8=252V, sagging to 220-8-(150x0.01)=210V under steady-state heavy load.

For a peak plate current of 90mA, then the nominal output power of the amplifier would be: (Ipk)<sup>2</sup> x Rpp / 8 = 0.09 x 0.09 x 12k / 8 = 10W. For this maximum signal condition, the rms OPT current draw is likely about 6mA (64% of peak), and the average VS1 power consumed is about 290V x 0.06Arms =17W, and the OPT loss is about (0.06)<sup>2</sup> x 55Ω = 0.2W, so the tube plates dissipate 17 - 10W = 7W, or just under 3.5W each, which is well below max design level.

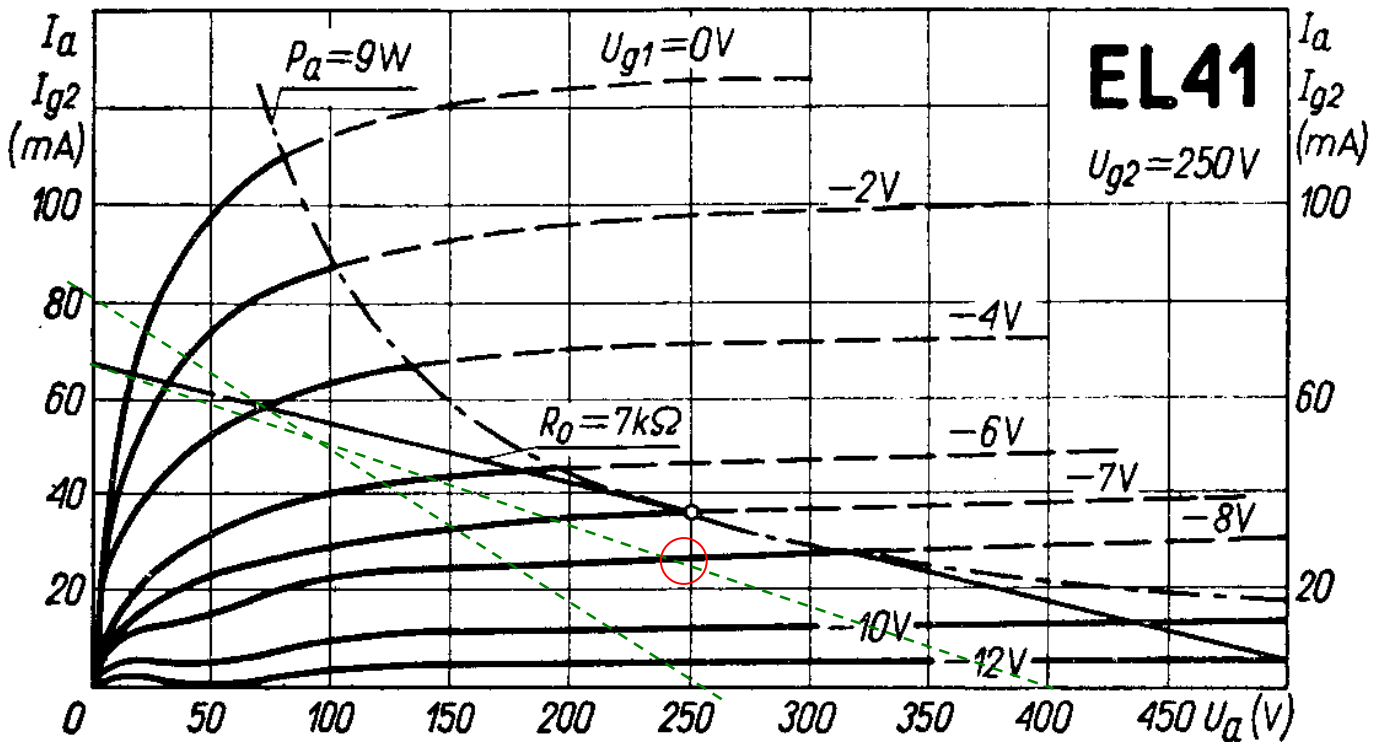

### 3.5 Power Supplies

The original 6V4 was faulty. To simplify restoration, the 6V4 was replaced with two series connections of 1N5060 with series 560R 10W, but then reverted to 6V4 with series 1N4007 protection diodes added. RC filters for VS2 and VS3.

Target VS1 loading is 250V at 70mA. The 6V4G / EZ80 is rated to feed 50uF with secondary winding resistance  $>125\Omega$  from 250VAC, and 90mA loading for a 265VDC output. The effective series resistance is  $30\Omega \times (250/240)^2 + 185\Omega = 217\Omega$ , which is fine.

PSUD2 indicates 70mAdc at 263Vdc for 3.75k load. Peak continuous diode current of 82mA, so well below 270mA limit. Hot turn-on peak of 900mA, which is the limit level.

The continuous fuse current in the CT link is about 115mA rms nominal for 70mA dc load. A 125mA T 5x20 is ok.

Simulate period in PSUD2	10ms	20ms	50ms	150ms	600ms	continuous
Simulated RMS current		0.45A		0.21A	0.15A	0.12A
Multiplier (for 125mA fuse rating)		3.6		1.7	1.2	0.92
IEC 60127-2 T min limit multiplier		10		4.0	2.75	1

A 125mA F fuse is not appropriate as 10ms multiplier is exceeded.

Bleed resistors on VS1: 4k4+150k+27k, and 180k+1k8+62.

Monitoring: use common cathode 5-pin McMurdo interface to 8x meter with 30VFS cathode.

# INTERCOM 6 LINE

MOD. NO. 1173

SER. NO. 1064

TYPE 2517  
7K5 P-P

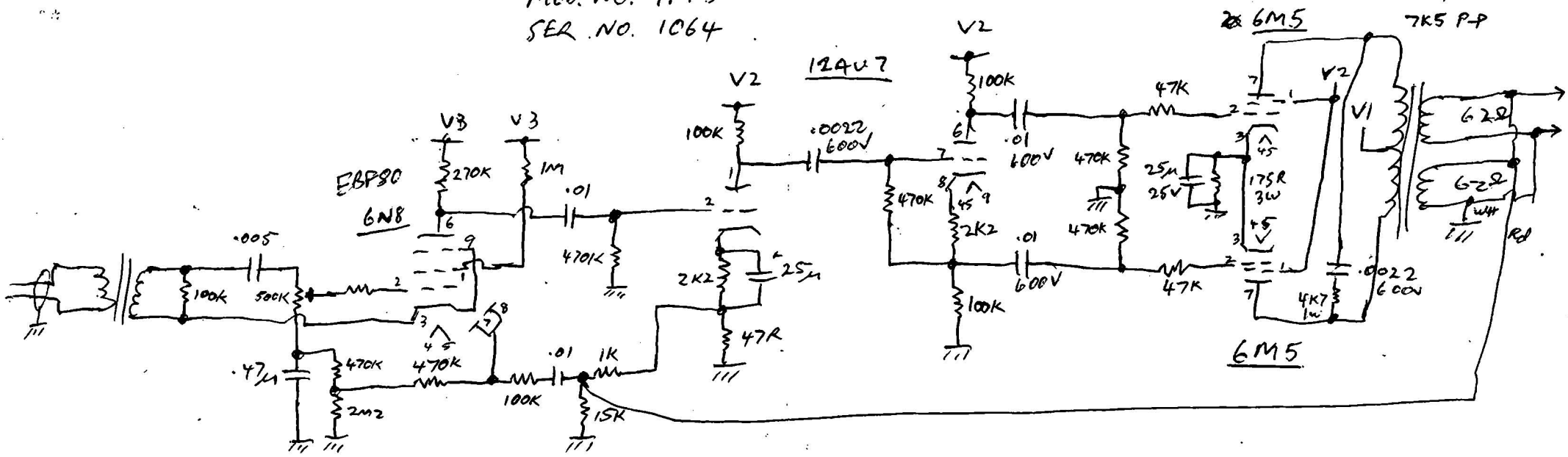

DC RESISTANCES

PRIM :	BLK - BW	30 Ω
	BLK - RD	26 Ω
SEC :	185 Ω + 185 Ω	
P-P :	190 Ω	
SEC :	3 - 4 Ω	

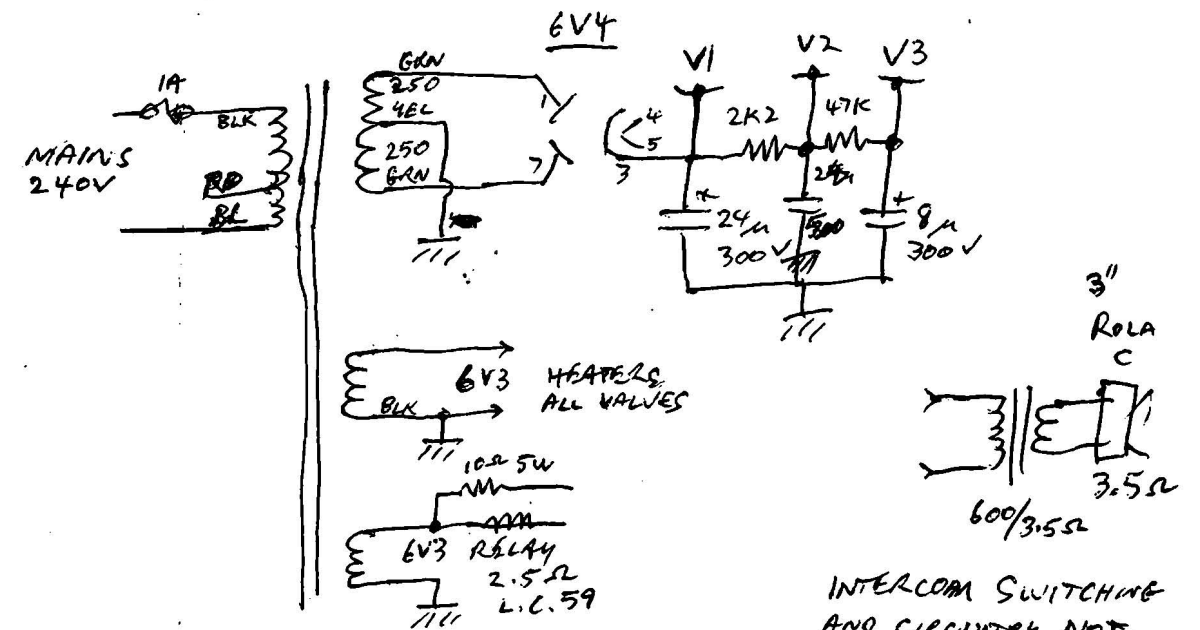

INTERCOM SWITCHING AND CIRCUITRY NOT SHOWN.



**INTERCOM 6-LINE**  
 MODIFIED 2025      MOD. NO. 1173  
    SER. NO. 1064

